

FAELUX

La Finestra per Tetti



SCHEDE TECNICHE finestre Faelux

modelli:
BA-VB-VL-Lplus

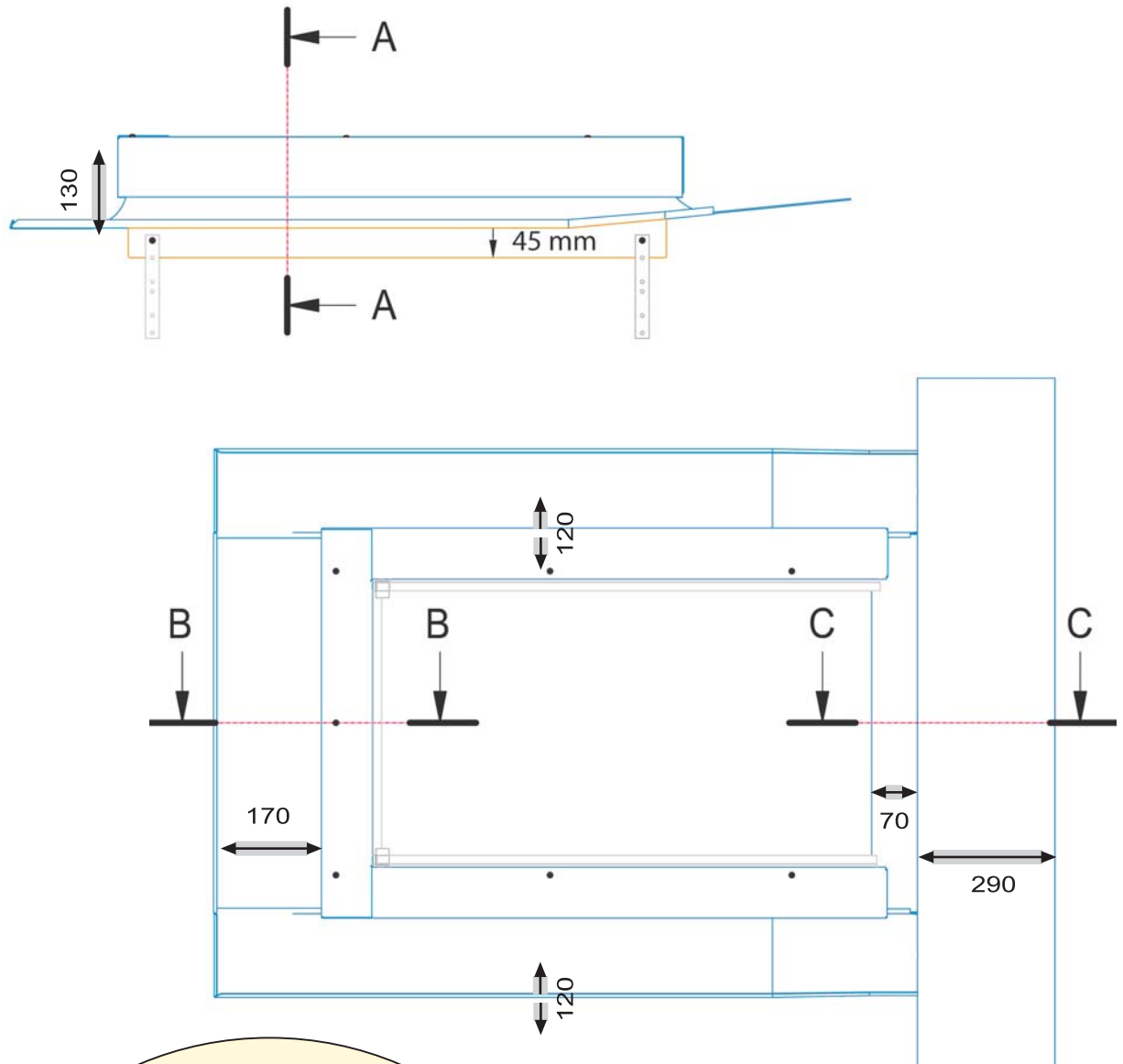

Caratteristiche materiali

Telaio e battente in legno:

- abete nordico massiccio giuntato "FINGER-JOINT"
- impregnante antimuffa e antitarlo
- verniciatura a base acqua

Conversa e cornice esterne:

- alluminio preverniciato a fuoco colore "TESTA DI MORO"
- rame naturale

Guarnizioni:

- a palloncino EPDM

Vetrate:

- vedi capitolo vetrate

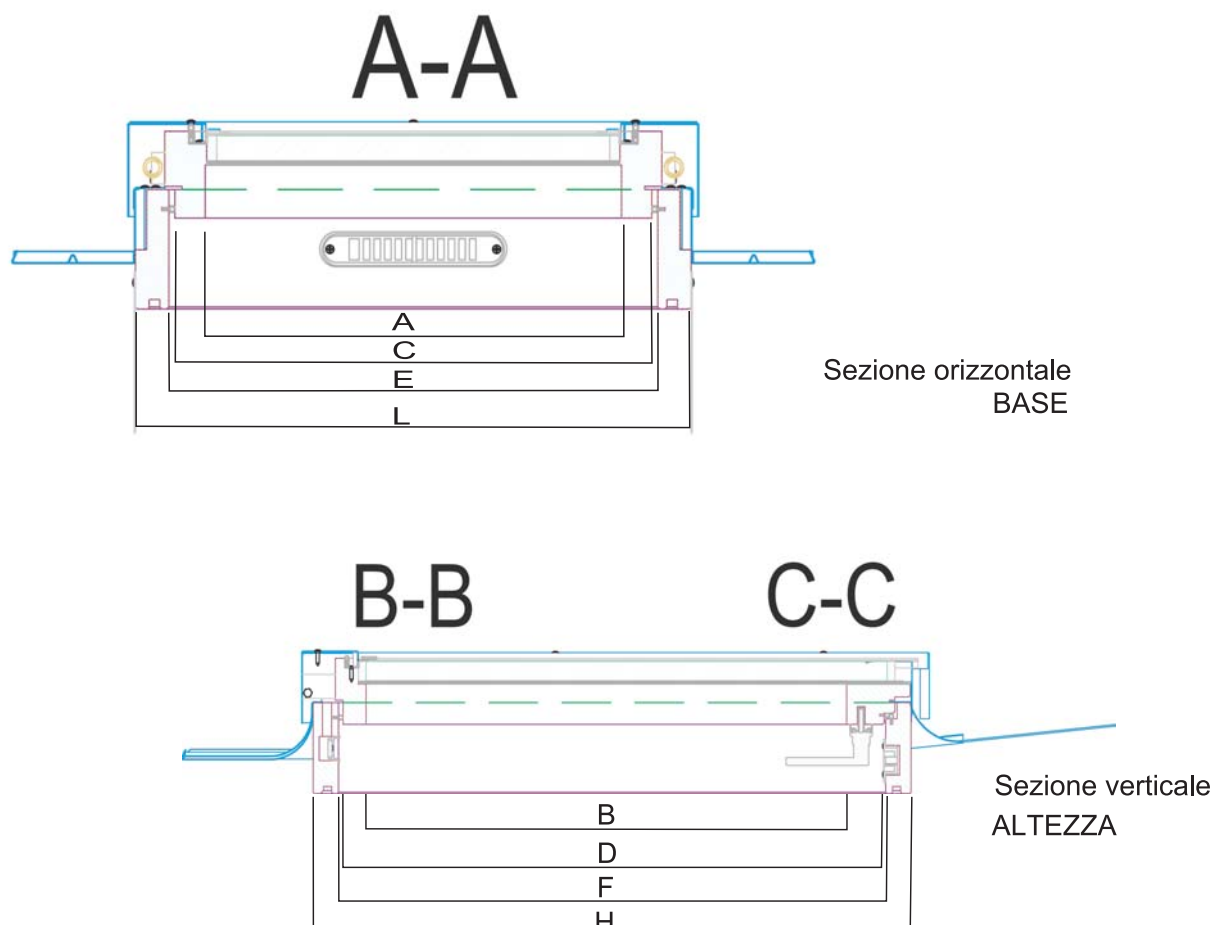

Dimensioni

Tabella dimensioni																			
Dimensioni nominali	L	450	550	550	450	550	660	700	780	780	780	940	940	940	940	1140	1140	1340	1340
	H	980	700	780	980	980	1180	1180	980	1180	1400	550	700	980	1600	1180	1400	980	1400
Dimensioni foro muratura	L	460	560	560	460	560	670	710	790	790	790	950	950	950	950	1150	1150	1350	1350
	H	990	710	790	990	990	1190	1190	990	1190	1410	560	710	990	1610	1190	1410	990	1410
Area vetrata	mq.	0,240	0,210	0,240	0,240	0,320	0,510	0,550	0,510	0,630	0,770	0,300	0,430	0,640	1,120	1,000	1,290	0,970	1,470
Dimensioni battente interno	A	288	388	388	288	388	498	538	618	618	618	778	778	778	778	978	978	1178	1178
	B	818	538	618	818	818	1018	1018	818	1018	1238	388	538	818	1438	1018	1238	818	1238
Dimensioni battente esterno	C	376	476	476	376	476	586	626	706	706	706	866	866	866	866	1066	1066	1266	1266
	D	906	626	706	906	906	1106	1106	906	1106	1326	476	626	906	1526	1106	1326	906	1326
Dimensioni telaio interno	E	386	486	486	386	486	596	636	716	716	716	876	876	876	876	1076	1076	1276	1276
	F	916	636	716	916	916	1116	1116	916	1116	1336	486	636	916	1536	1116	1336	916	1336
Dimensioni telaio esterno	L	450	550	550	450	550	660	700	780	780	780	940	940	940	940	1140	1140	1340	1340
	H	980	700	780	980	980	1180	1180	980	1180	1400	550	700	980	1600	1180	1400	980	1400
Superf.apribile	mq.	0,372	0,325	0,365	0,372	0,465	0,666	0,734	0,678	0,806	0,985	0,431	0,580	0,827	1,379	1,230	1,425	1,199	1,740
Peso alluminio	Kg.	22	19	21	22	25	31	34	31	37	43	25	26	37	56	48	55	47	62
Peso rame	Kg.	24	22	24	24	28	35	38	35	42	48	28	30	42	63	54	60	53	69
Dimensioni imballo	Largh.	770	870	870	770	870	980	1020	1100	1100	1100	1260	1260	1260	1260	1460	1460	1660	1660
	Lungh.	1270	990	1070	1270	1270	1470	1470	1270	1470	1690	840	900	1270	1890	1470	1690	1270	1690
	Altezza	180	180	180	180	180	180	180	180	180	180	180	180	180	180	180	180	180	180

Vetrare

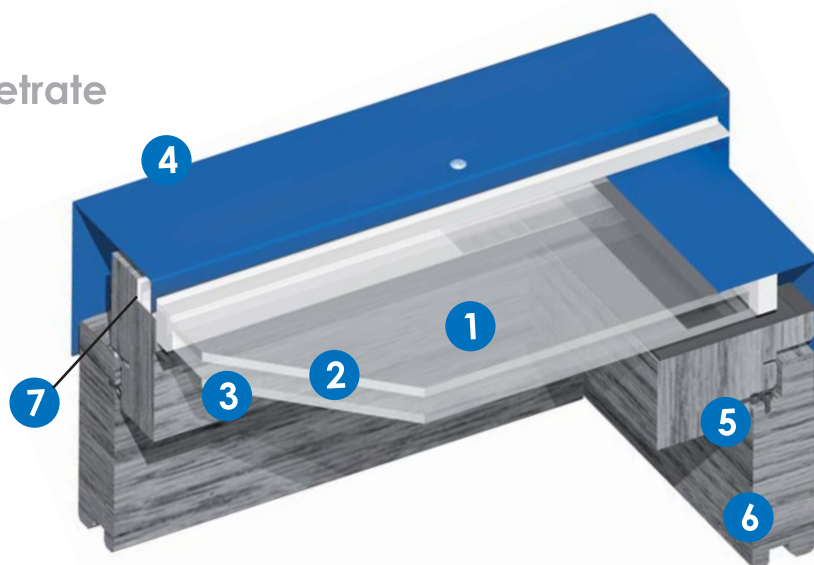

- 1 Lastra vetrata esterna
- 2 Camera vetro isolante
- 3 Lastra vetrata interna
- 4 Cornice di protezione esterna in alluminio o in rame
- 5 Guarnizioni in EPDM
- 6 Telaio e battente in legno
- 7 Profilo fermavetro

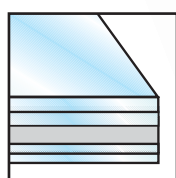

K14 ACUSTICO:
 Vetrata 4/4.2-15Argon -3/3b.e.
 Ug = 1,0 W(mqK)
 - antigrandine
 - antisfondamento
 - sicurezza
 - isolamento termico ed acustico

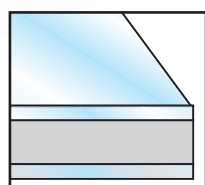

K16
 Vetrata 4 - 16 - 4b.e.
 Ug = 1,1 W(mqK)
 - isolamento termico

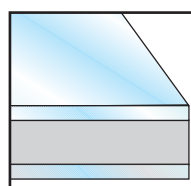

BASE:
 Vetrata 4 - 16 - 4
 Ug = 2.7 W(mqK)
ATTENZIONE! Vetrata non idonea per ambienti ad uso abitativo

VETRATA CONSIGLIATA

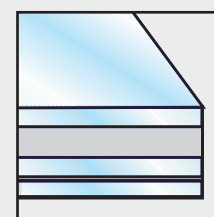



















K14:
 Vetrata 4temp.-15Argon -3/3b.e.
 Ug = 1,0 W(mqK)
 - antigrandine
 - sicurezza
 - isolamento termico

Certificazioni

Tipologia di TEST	Unità di misura	Norma di riferim.	CLASSE				
			BA	VB	VL	L plus	
Permeabilità all'aria in pressione	KPa	UNI EN 12207	4	3	3	3	
Permeabilità all'aria in depressione	KPa	UNI EN 12207	3	4	2	2	
Tenuta all'acqua	Pa	UNI EN 12208	E900	E1200	7A	7A	
Resistenza al carico del vento	Pa	UNI EN 12210	C3	C1	C2	C2	
Potere fonoisolante	Rw	UNI EN 717-1:2007	35dB(K14)	-	-	-	
Trasmittanza termica - Uw	W/mq	UNI EN 14351-1:2006	Zona climatica				
Vetrata Ug =1.0			1,4	1,5	1,6	1,6	F
Vetrata Ug =1.1			1,6	1,6	1,7	1,7	F (BA-VB):E (VL-Lplus)
Vetrata Base Ug = 2.7			2,7	2,8	2,9	2,9	A

Misure standard (LxH) e pendenze di esercizio (°)





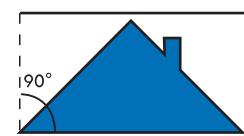







Modello BA

 45x98	 55x70	 55x78	 55x98	 66x118	 70x118	 78x98	 78x118	 78x140
 94x55	 94x70	 94x98	 94x160	 114x78	 114x118	 114x140	 134x98	 134x140



Si può installare con pendenze comprese fra i 12° e i 90°





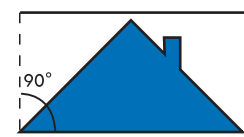



Modello VB

 45x98	 55x78	 55x98	 66x118	 70x118	 78x98	 78x140
 94x98	 94x160	 114x118	 114x140	 134x98	 134x140	



Si può installare con pendenze comprese fra i 12° e i 90°

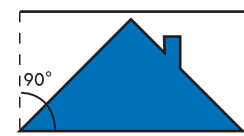

Modello VL

 55x70	 55x78	 55x98	 70x118	 78x98	 94x70	 94x98	 114x78
--	--	--	---	--	--	--	--



Si può installare con pendenze comprese fra gli 8° e i 90°

Modello Lplus

 55x98	 66x118	 78x98
--	---	--

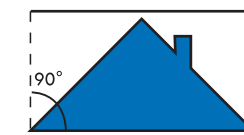

Si può installare con pendenze comprese fra gli 8° e i 90°

Raccordi

La finestra modello BA viene fornita con il raccordo o conversa monoblocco pre/assemblata con il sistema di deflusso dell'acqua piovana.

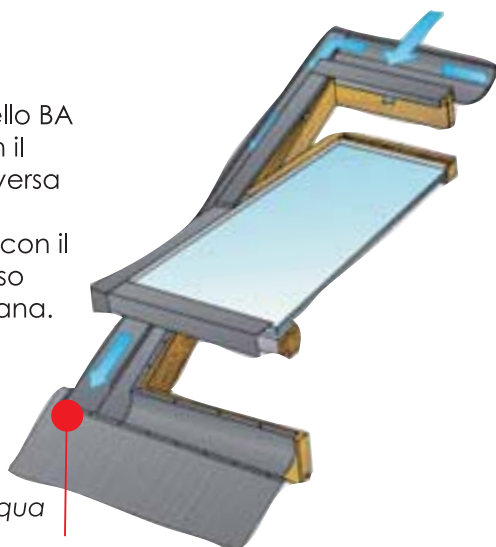

Deflusso acqua piovana



La lunghezza del piombo plissettato è di 33 cm di cui 29 utili. Il raccordo è dotato di grembialina in piombo nella parte bassa per il sormonto delle tegole o coppi.

Maniglia

1

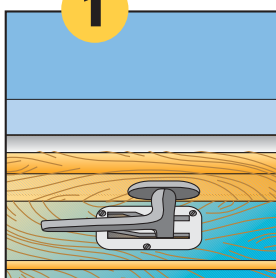

Le finestre Faelux hanno la maniglia posizionata nella parte bassa del battente che consente di:

- 1) Aprire e chiudere ermeticamente la finestra ad anta assicurata. **Fig1**
- 2) Finestra bloccata e anta assicurata ma in posizione di ventilazione. **Fig2**

2

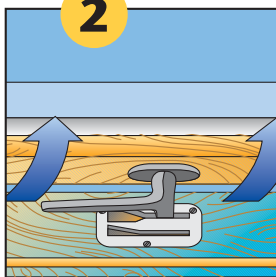

Ventilazione

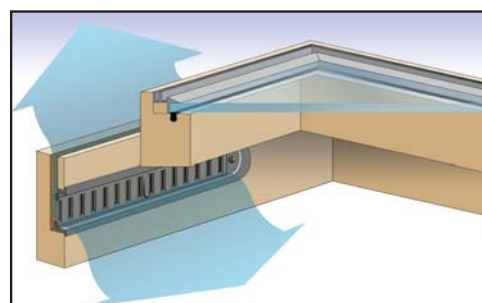

Espulsione condensa

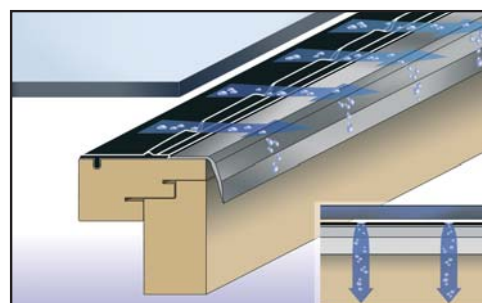

Accessori

Alle Finestre Faelux possono essere applicati

- Avvolgibile esterna elettrica
- Tenda esterna parasole manuale
- Tenda esterna parasole elettrica
- Tenda esterna oscurante elettrica
- Tenda interna oscurante/filtrante manuale o elettrica
- Tenda interna abbinata manuale
- Tenda interna con gancetti manuale
- Tenda interna plissè manuale
- Tenda interna veneziana manuale
- Zanzariera manuale (fronte muro)
- Asta con occhiello
- Dispositivo meccanico manuale + asta
- Comando elettrico con apertura a catena KATO 220V
- Comando elettrico con apertura a catena KATO 24V
- Comando elettrico con apertura a catena KATO Radio 220V
- Comando elettrico con apertura a catena KATO Tris 220V
- Cassetto coprimotore
- Sistemi rilevazione pioggia / vento
- Sistemi radiocomandi a distanza
- Sistemi di sicurezza (evacuazione fumo e calore)

Modello BA - componenti

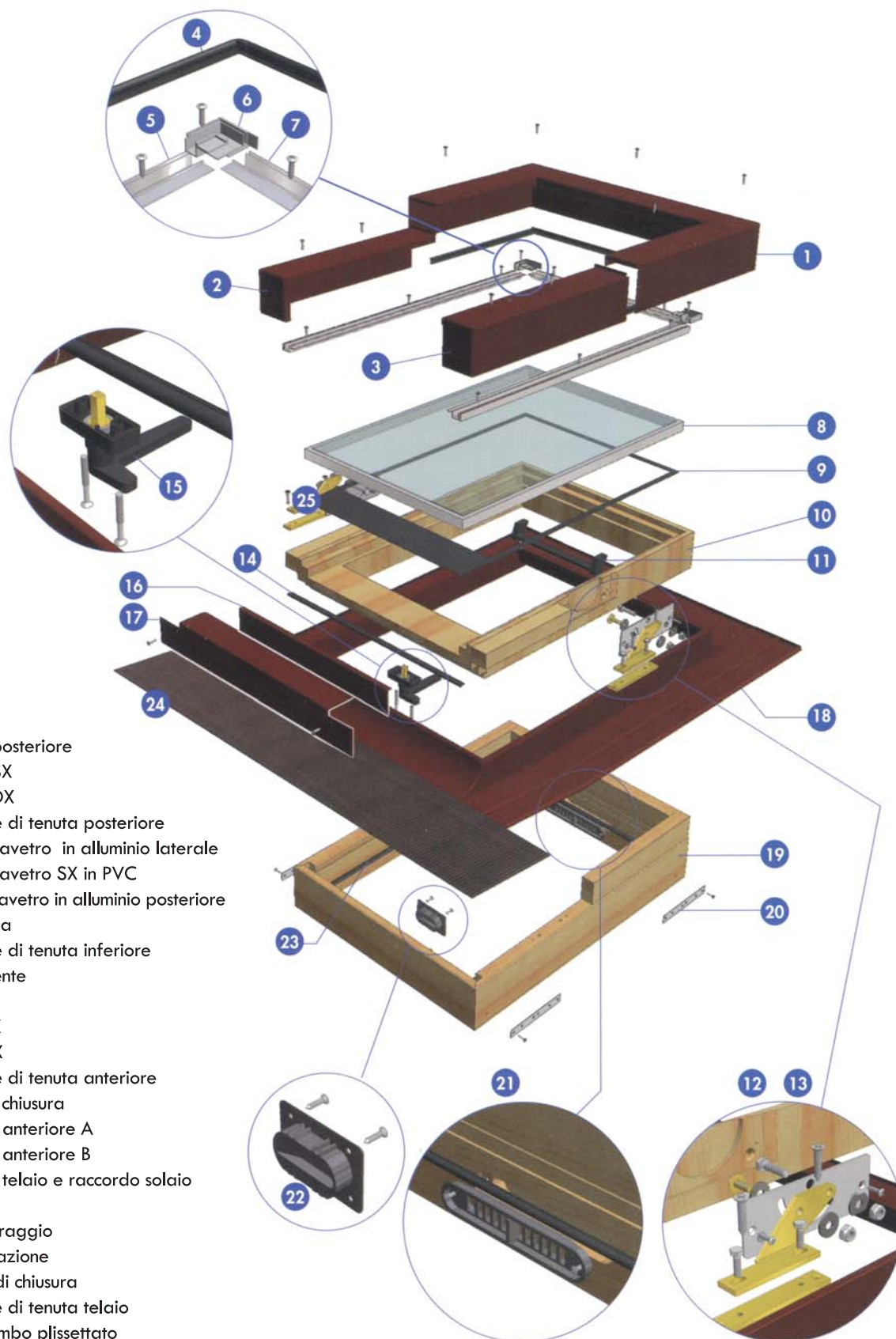

- 1 Crenatura posteriore
- 2 Crenatura SX
- 3 Crenatura DX
- 4 Guarnizione di tenuta posteriore
- 5 Profilo fermavetro in alluminio laterale
- 6 Profilo fermavetro SX in PVC
- 7 Profilo fermavetro in alluminio posteriore
- 8 vetro camera
- 9 Guarnizione di tenuta inferiore
- 10 Telaio battente
- 11 Maniglia
- 12 Cerniera SX
- 13 Cerniera DX
- 14 Guarnizione di tenuta anteriore
- 15 Maniglia di chiusura
- 16 Carenatura anteriore A
- 17 Carenatura anteriore B
- 18 Carenatura telaio e raccordo solaio
- 19 Telaio fisso
- 20 Staffe ancoraggio
- 21 Griglia areazione
- 22 Dispositivo di chiusura
- 23 Guarnizione di tenuta telaio
- 24 Faldale piombo plissettato
- 25 Guarnizione per espulsione condensa

Modello BA - particolari

Rimozione battente

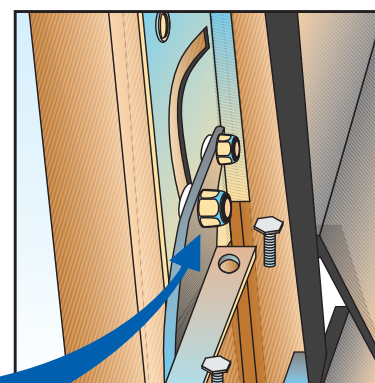
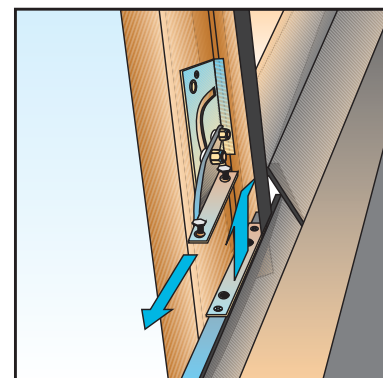
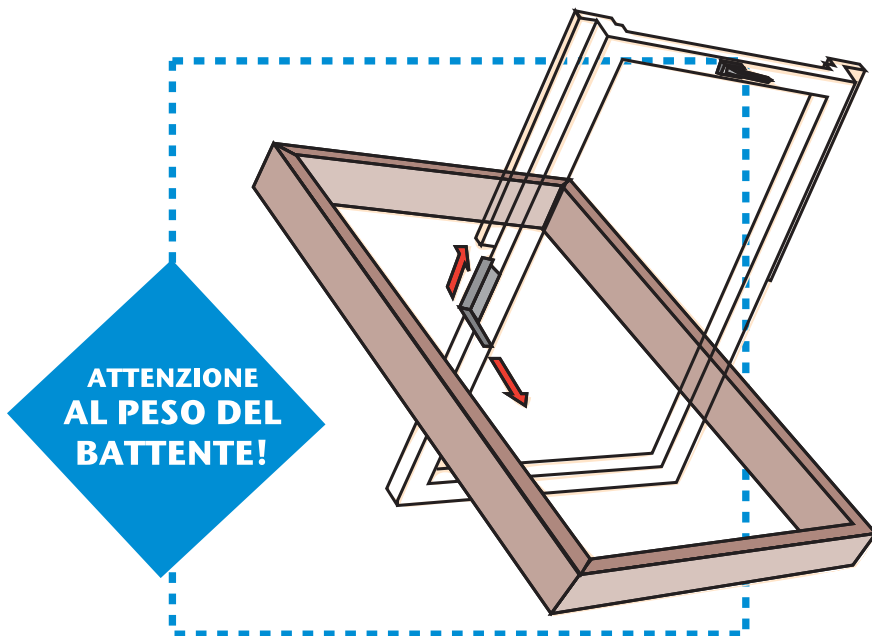

REGOLAZIONE FRIZIONE DELL'ANTA CON CHIAVE DA 13

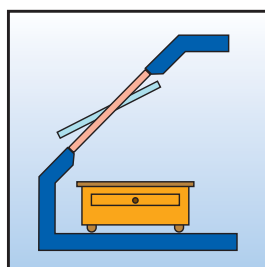
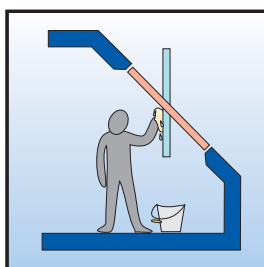
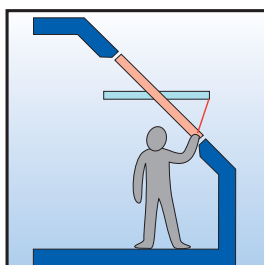

Il sistema basculante permette di regolare l'apertura della finestra in qualsiasi posizione consentendo una perfetta aereazione ed un continuo ricambio dell'aria. La rotazione del battente a 130°agevola inoltre una facile pulizia del vetro esterno.



Modello VB - componenti

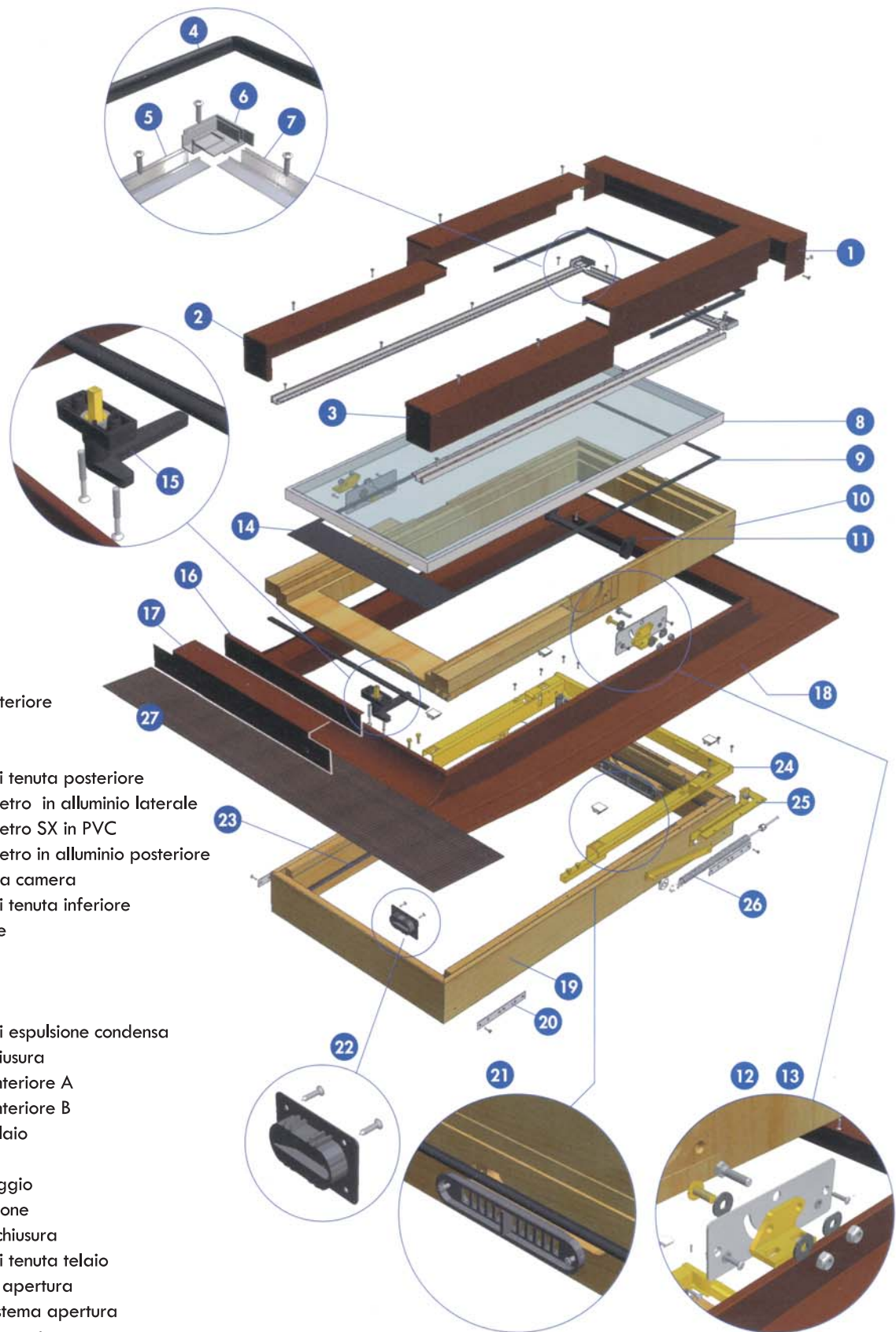

- 1 Crenatura posteriore
- 2 Crenatura SX
- 3 Crenatura DX
- 4 Guarnizione di tenuta posteriore
- 5 Profilo fermavetro in alluminio laterale
- 6 Profilo fermavetro SX in PVC
- 7 Profilo fermavetro in alluminio posteriore
- 8 Vetro a doppia camera
- 9 Guarnizione di tenuta inferiore
- 10 Telaio battente
- 11 Maniglia
- 12 Cerniera SX
- 13 Cerniera DX
- 14 Guarnizione di espulsione condensa
- 15 Maniglia di chiusura
- 16 Carenatura anteriore A
- 17 Carenatura anteriore B
- 18 Carenatura telaio
- 19 Telaio fisso
- 20 Staffe ancoraggio
- 21 Griglia areazione
- 22 Dispositivo di chiusura
- 23 Guarnizione di tenuta telaio
- 24 Telaio sistema apertura
- 25 Ancoraggio sistema apertura
- 26 Molla sistema apertura
- 27 Faldale piombo plissettato

Modello VB - particolari

Rimozione battente

**ATTENZIONE
AL PESO DEL
BATTENTE!**

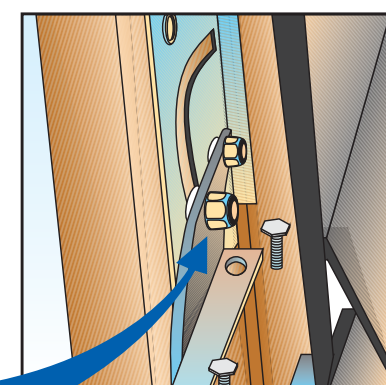
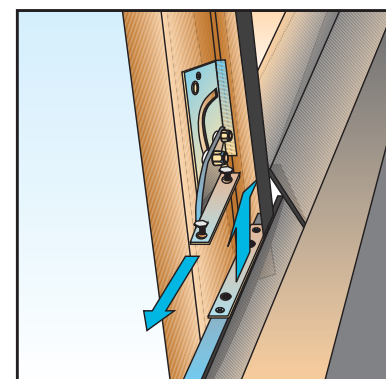
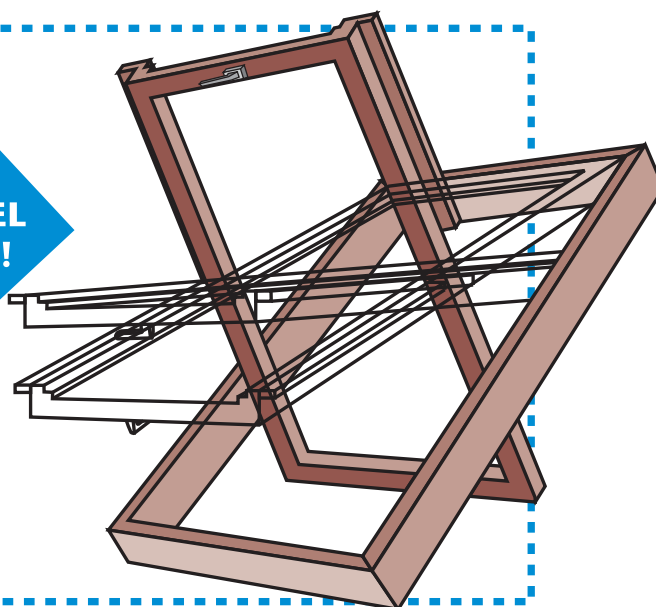

REGOLAZIONE FRIZIONE
DELL'ANTA CON CHIAVE DA 13

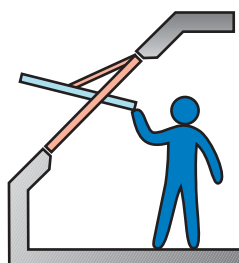
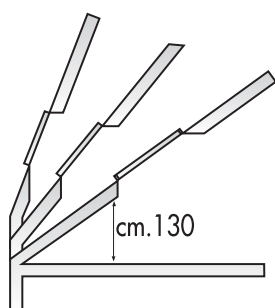

Per ottenere l'apertura a loggia o a bilico occorre agire sul pulsante posto dietro la maniglia superiore e, tenendolo premuto, tirare la maniglia verso il basso. Per riportare la finestra in posizione di vasistas, spingere verso l'alto usando la maniglia superiore.

Per chiudere completamente la finestra invece tirare agendo sulla maniglia inferiore.

La finestra mod. VB dotata di avvolgibile elettrica può diventare per la vostra mansarda un'elegante e piacevole veranda estiva.

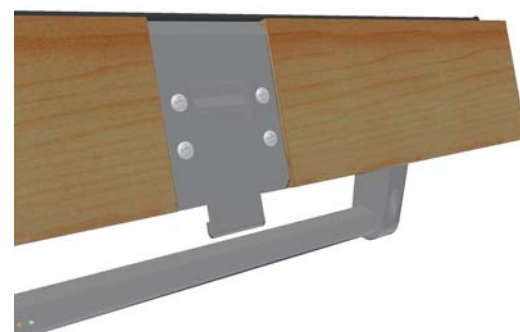
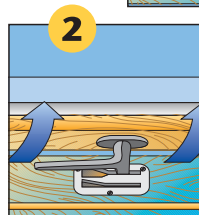
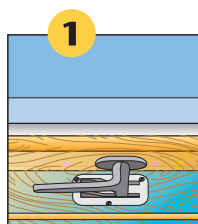

Modello VL - componenti

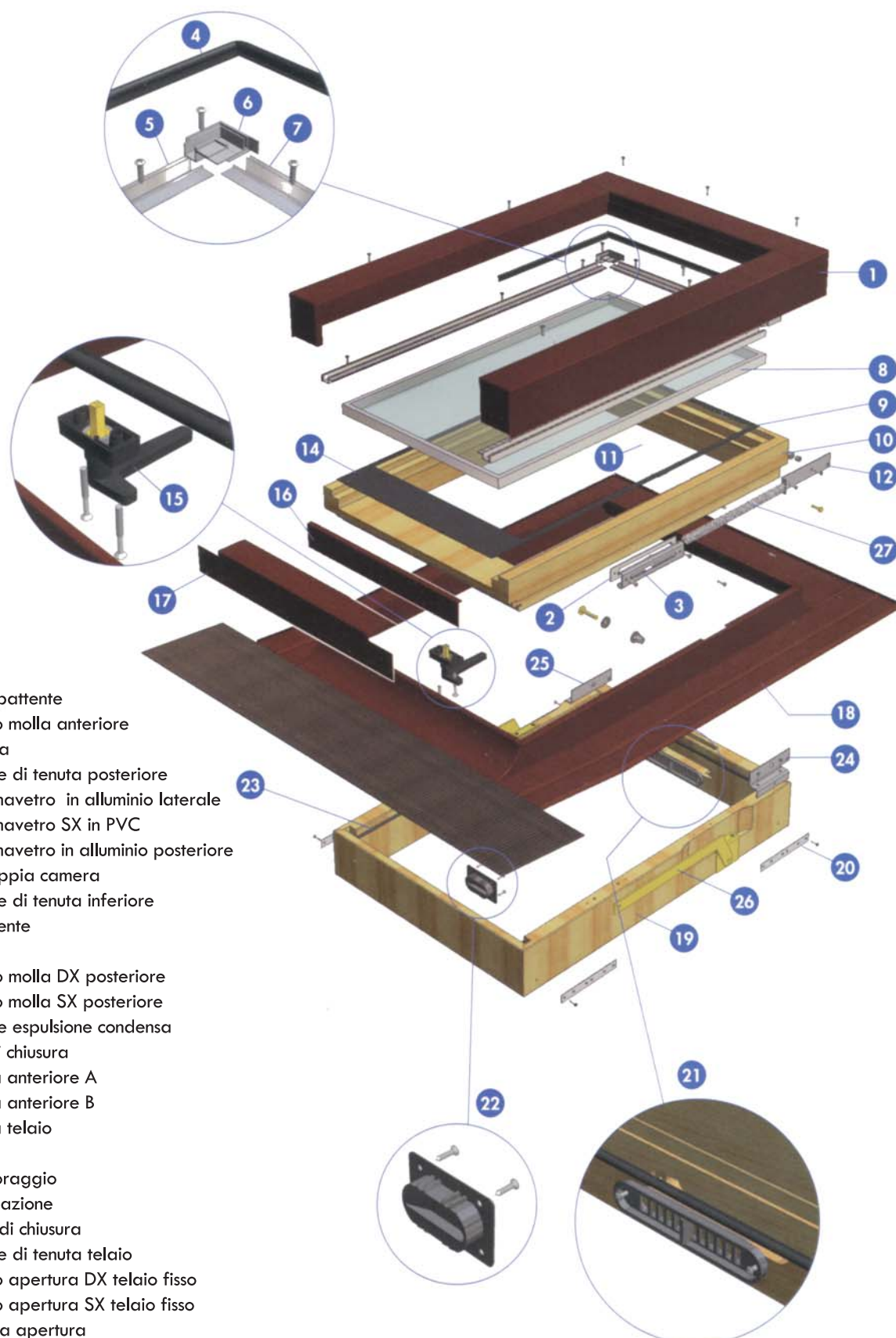

- 1 Crenatura battente
- 2 Ancoraggio molla anteriore
- 3 Guida molla
- 4 Guarnizione di tenuta posteriore
- 5 Profilo fermavetro in alluminio laterale
- 6 Profilo fermavetro SX in PVC
- 7 Profilo fermavetro in alluminio posteriore
- 8 Vetro a doppia camera
- 9 Guarnizione di tenuta inferiore
- 10 Telaio battente
- 11 Maniglia
- 12 Ancoraggio molla DX posteriore
- 13 Ancoraggio molla SX posteriore
- 14 Guarnizione espulsione condensa
- 15 Maniglia di chiusura
- 16 Carenatura anteriore A
- 17 Carenatura anteriore B
- 18 Carenatura telaio
- 19 Telaio fisso
- 20 Staffe ancoraggio
- 21 Griglia areazione
- 22 Dispositivo di chiusura
- 23 Guarnizione di tenuta telaio
- 24 Ancoraggio apertura DX telaio fisso
- 25 Ancoraggio apertura SX telaio fisso
- 26 Leva sistema apertura

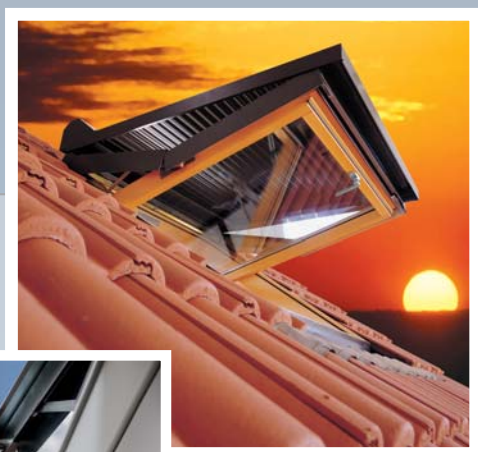

FAELUX®

FAELUX srl
Via Caduti di Via Fani, 640
47032 CAPOCOLLE di BERTINORO
(FORLÌ - ITALY)
+39 0543 448235 - Fax +39 0543 448697

www.faelux.it
info@faelux.it

FAELUX®