

# FAELUX

La Finestra per Tetti



*SCHEDE TECNICHE*  
*lucernari Faelux*

*modelli:*  
*Jolly - Super export -L*

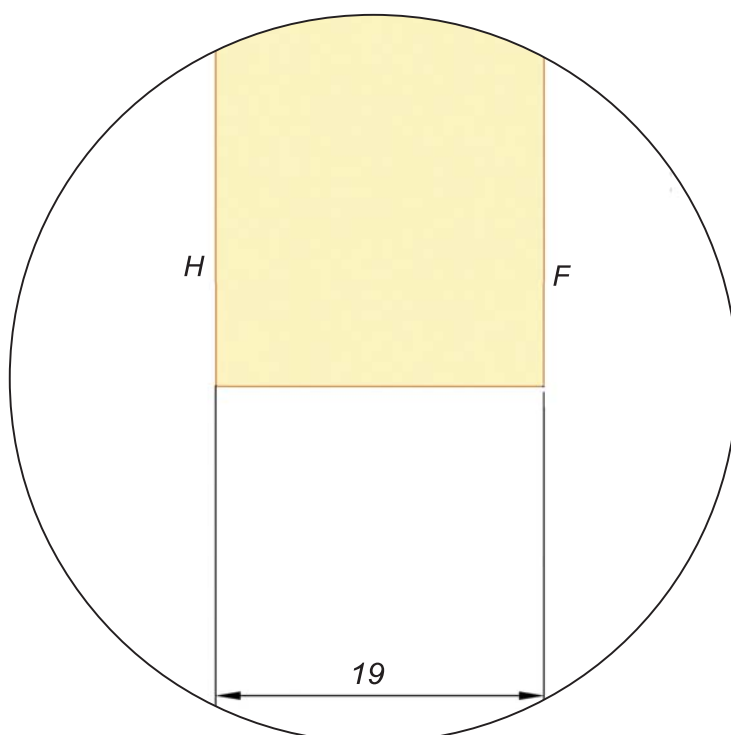
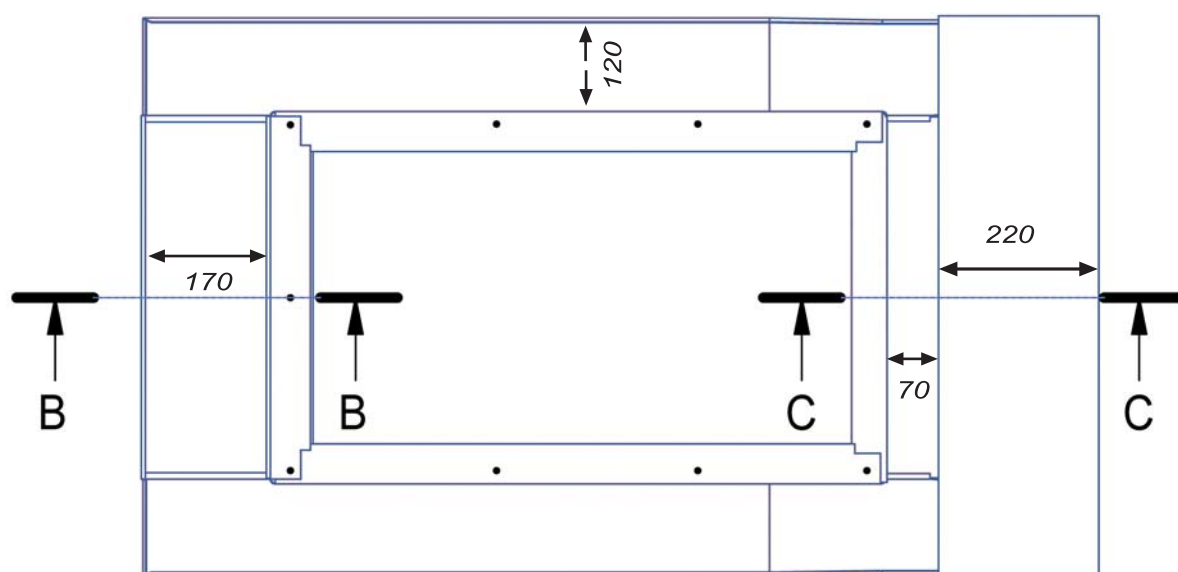
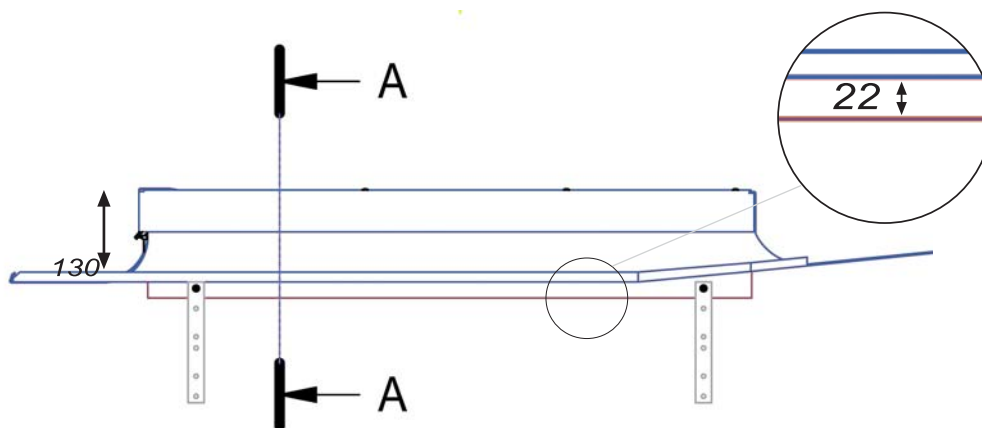

### Caratteristiche materiali

Telaio e battente in legno:

- abete nordico massiccio giuntato "FINGER-JOINT"
- impregnante antimuffa e antitarlo

Conversa e cornice esterne:

- alluminio preverniciato a fuoco colore "TESTA DI MORO"
- rame naturale

Guarnizioni:

- a palloncino EPDM

Vetrate:

- vedi capitolo vetrate

B-B C-C

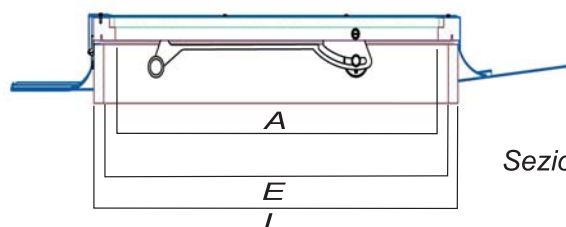

Sezione orizzontale  
BASE

B-B C-C

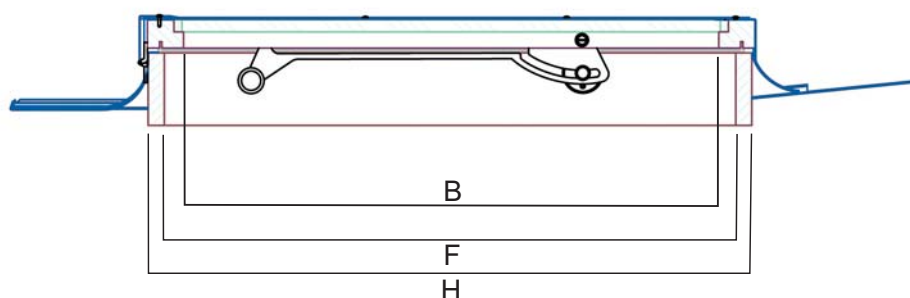

Sezione verticale  
ALTEZZA

### Dimensioni

Tabella dimensioni													
Dimensioni nominali	L	450	450	450	480	550	550	660	780	780	880	940	1000
	H	550	750	980	800	780	980	1180	980	1180	450	700	500
Dimensioni foro muratura	L	460	460	460	490	560	560	670	790	790	890	950	1010
	H	560	760	990	810	790	990	1190	990	1190	460	710	510
Area vetrata	mq.	0,170	0,241	0,327	0,280	0,323	0,418	0,628	0,618	0,757	0,292	0,523	0,382
Dimensioni battente interno	A	363	363	363	393	463	463	573	693	693	793	853	913
	B	463	663	893	713	693	893	1093	893	1093	363	613	413
Dimensioni battente esterno	C	450	450	450	480	550	550	660	780	780	880	940	1000
	D	550	750	980	800	780	980	1180	980	1180	450	700	500
Dimensioni telaio interno	E	412	412	412	442	512	512	622	742	742	842	962	902
	F	512	712	942	762	742	942	1142	942	1142	412	462	662
Superf.apribile	mq.	0,210	0,290	0,385	0,336	0,380	0,480	0,706	0,695	0,847	0,344	0,444	0,597
Peso alluminio	Kg.	12	14	17	16	17	19	26	24	28	17	18	25
Peso rame	Kg.	14	16	19	18	10	22	30	28	32	19	21	29
Dimensioni imballo	Largh.	770	770	770	800	770	870	980	1100	1100	1200	1320	1260
	Lungh.	840	1040	1270	1090	1270	1270	1470	1270	1470	740	790	990
	Altezza	160	160	160	160	160	160	160	160	160	160	160	160

VETRATA CONSIGLIATA

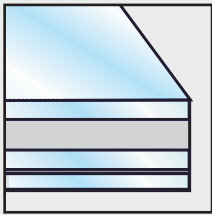

Vetrata 4 - 9 - 3/3be  
 $U_g=1,6 \text{ K(mqW)}$   
 - sicurezza  
 - isolamento termico

SOLO MODELLO JOLLY

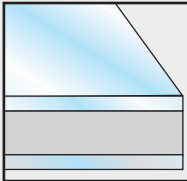

Vetrata 4 - 16 - 4be  
 $U_g=1,1 \text{ K(mqW)}$   
 - isolamento termico

ATTENZIONE:  
 Unica vetrata per ambienti abitabili

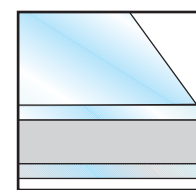

Vetrata Standard 4 - 9 - 4  
 $U_g=2,7 \text{ K(mqW)}$

Apertura mod. Super Export

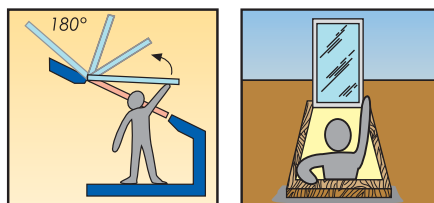

Apertura a ribalta fino a 180°

Apertura mod. L

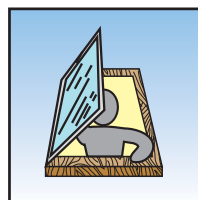

Apertura laterale fino a 90°

Apertura mod. Jolly

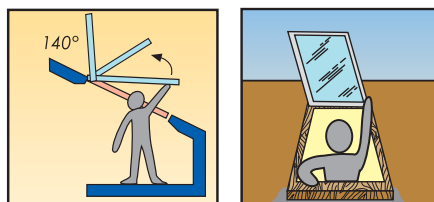







Apertura a ribalta fino a 140°

Certificazioni 

Tipologia di TEST	Unità di misura	Norma di riferim.	CLASSE			
			Jolly	Super Export	L	
Permeabilità all'aria in pressione	KPa	UNI EN 12207	4	4	2	
Permeabilità all'aria in depressione	KPa	UNI EN 12207	2	2	1	
Tenuta all'acqua	Pa	UNI EN 12208	E900	E900	7A	
Resistenza al carico del vento	Pa	UNI EN 12210	C3	C3	C2	
Trasmittanza termica - $U_w$	W/mq	UNI EN 14351-1:2006	Zona climatica			
Vetrata $U_g = 1.1$ (4-16-4 solo Jolly)			1,8	-	-	E
Vetrata $U_g = 1.6$ (4-9-3/3 S.Export - L)			-	2,5	2,5	B
Vetrata Base $U_g = 2.7$ (4-9-4)			-	3,3	3,3	A

Misure standard (LxH) e pendenze di esercizio (°)





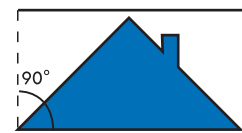



Modello JOLLY

						
45x98	55x78	55x98	66x118	78x98	78x118	94x70



Si può installare con pendenze comprese fra gli 8° e i 15°

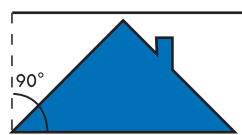

Modello SUPER EXPORT

							
45x55	45x75	45x98	55x78	55x98	78x98	88x45	100x50



Si può installare con pendenze comprese fra gli 8° e i 15°

Modello L

		
45x75	48x80	78x98

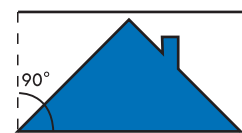

Si può installare con pendenze comprese fra gli 8° e i 15°

Raccordi

I Lucernari Faelux vengono forniti con il raccordo o conversa monoblocco pre/assemblata con il sistema di deflusso dell'acqua piovana.

Deflusso acqua piovana

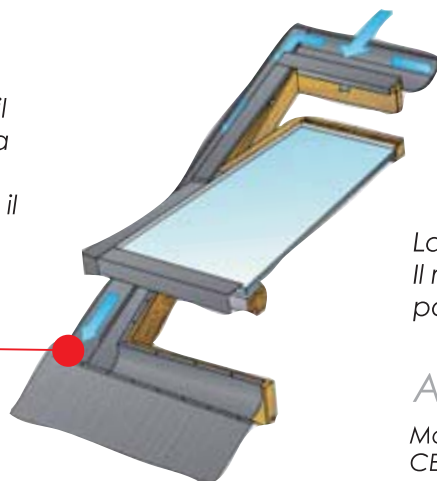

La lunghezza del piombo plissettato è di 22 cm utili. Il raccordo è dotato di grebbialina in piombo nella parte bassa per il sormonto delle tegole o coppi.

ATTENZIONE

Modelli Junior e Look sprovvisti di marchio CE, schede tecniche non disponibili



## Maniglia

1

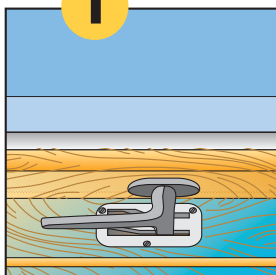

Nei modelli "JOLLY" e "L" è presente una maniglia che consente di:

1) Aprire e chiudere ermeticamente la finestra ad anta assicurata. Fig1

2) Finestra bloccata e anta assicurata ma in posizione di ventilazione. Fig2

2

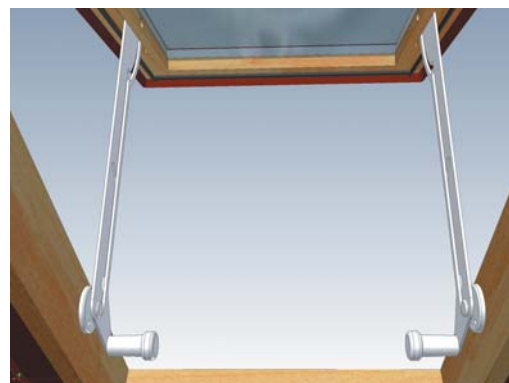
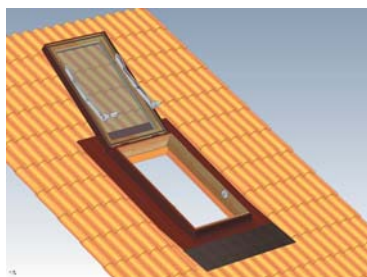
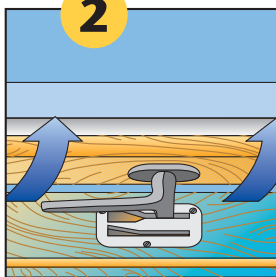

Apertura massima vincolata del battente modello "Super Export".  
Per il modello "Jolly" stesso sistema con maniglia a mezzaluna



Asola di sbloccaggio maniglie:  
modelli "Jolly" e "Super Export".



## Accessori

Ai Lucernari Faelux possono essere applicati

- Avvolgibile esterna elettrica
- Tenda interna oscurante /filtrante manuale o elettrica
- Dispositivo con cordone per tende
- Tenda interna con gancetti manuale
- Tenda interna veneziana manuale
- Zanzariera manuale ( fronte muro /fronte telaio)
- Asta con occhiello
- Dispositivo meccanico manuale + asta
- Comando elettrico con apertura a catena KATO 220V
- Cassetto coprimotore
- Sistemi rilevazione pioggia / vento
- Sistemi radiocomandi a distanza

## ATTENZIONE

La possibilità di ribaltamento dell' anta dovrà essere utilizzata solo ed esclusivamente in casi di necessità, in questo caso occorre operare in totale sicurezza. In fase di ribaltamento del battente fare attenzione al peso dello stesso

## Modello Super export - componenti

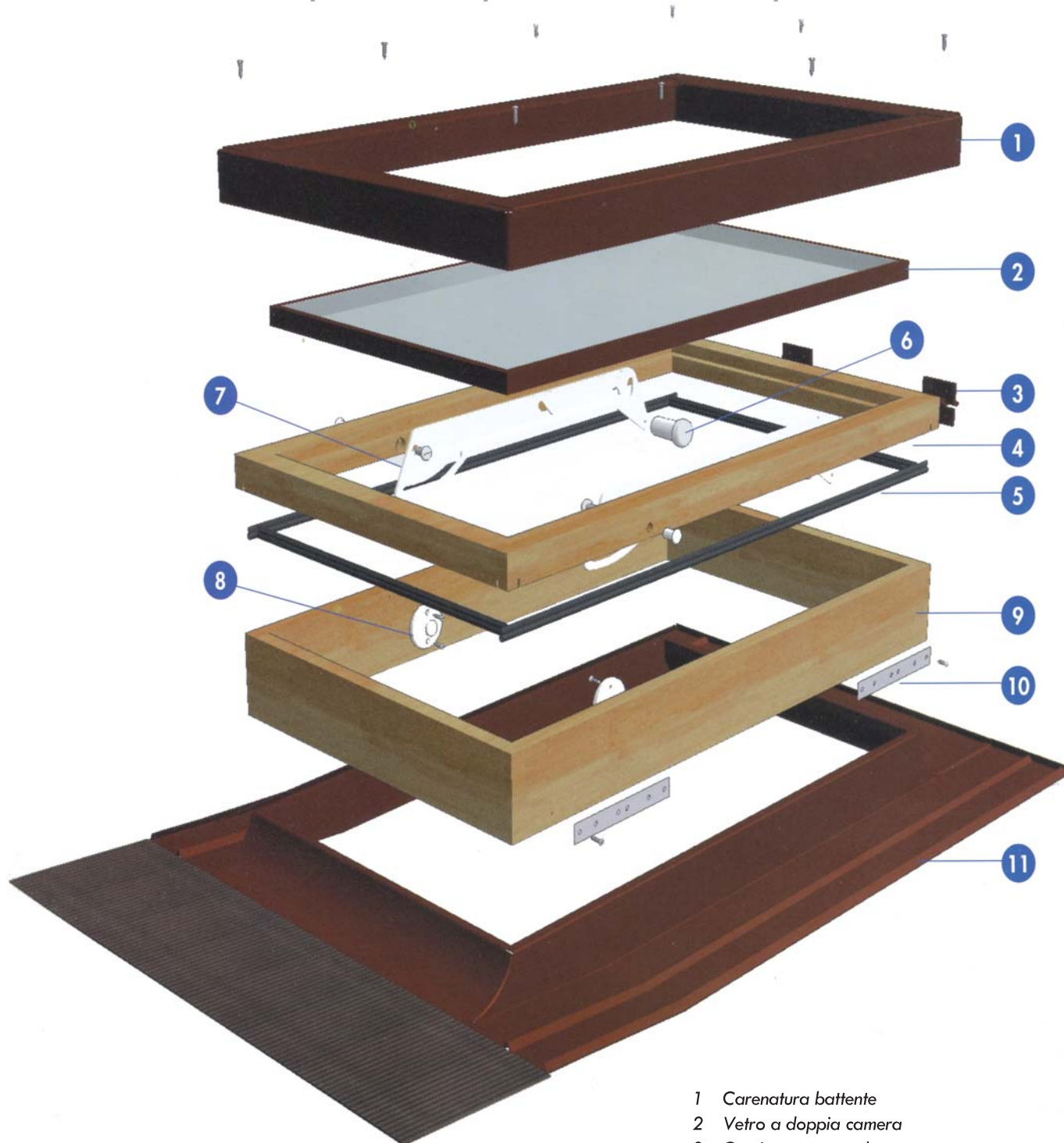

- 1 Carenatura battente
- 2 Vetro a doppia camera
- 3 Cerniera apertura battente
- 4 Telaio battente
- 5 Guarnizione di tenuta superiore
- 6 Pomello apertura
- 7 Staffa regolazione apertura
- 8 Fissaggio staffa regolazione apertura
- 9 Telaio fisso
- 10 Staffe ancoraggio
- 11 Carenatura telaio

